

Company profile



Green Field JSC

Al Hakel Alakdar

Power under control

Main fields of business



Green Field JSC

Al Hakel Alakdar
Power under control

Systems for the production of energy

Technological equipment

Integrated control

- Control rooms
- Verification of connections and power consumption
- Verification fault
- Verification counters
- Verification of site security
- Anti-theft occurs at sites

Management of energy systems

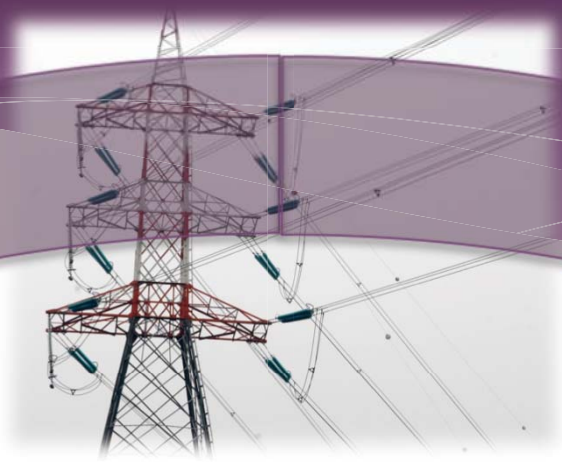

Green Field JSC

Al Hakel Alakdar
Power under control

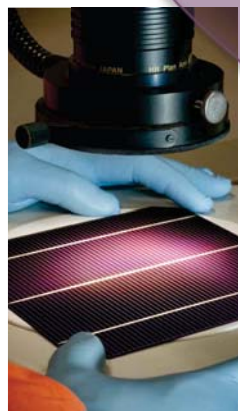
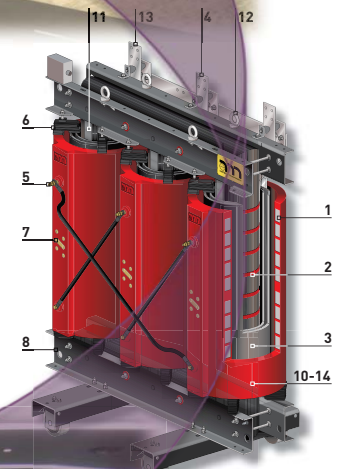

mase
GENERATORS



19-15

Our mission

- * Create integrated energy systems that allow you to produce power at an affordable cost to the economy and environment, so as to reduce to a minimum the consumption of hydrocarbons because, in our view for a country that produces hydrocarbons, the maximum benefit is to sell them, not to consume them.



Green Field JSC

Al Hakel Alakdar
Power under control



Wherever
Power
is required 



Official dealer of power generators



- * **power & welding specialists**

- * MASE GENERATORS SpA is one of the largest manufacturers of engine driven welders and generating sets. Founded in 1974, it gradually enlarged its range of products and extended its business throughout the world. The production facilities are located in Villanova d'Ardenghi, near Pavia and 47522 Cesena (FC) ITALY - Via Tortona, 345, and covers an area of more than 35,000 square meters.

- * The high quality of the products has its origins in industrial processes arising from research and development. MASE also constructs all the components needed for the manufacturing of its machines, thereby implementing the entire production cycle in-house. **In the factory at Villanova d'Ardenghi the company also designs and makes the asynchronous alternators that are installed both on the engine driven welders and on the generating sets.**

- * The company has ISO 9001 / UNI EN ISO 9001:2008 Quality System Certification and implements its standards in all its activities. The company's international success is also due to the technical assistance that is readily available in every corner of the world. MASE, through its sales network, is present in 1,200 sales outlets in Italy and in over 60 countries worldwide.

- * There are several production lines:

- * DC engine driven welders from 165A to 1000A
- * AC generating sets from 1kVA to 2000 kVA
- * Vehicular generators
- * P.T.O. Driven Generators
- * Lighting Towers



Official service of
technical assistance
in Libya

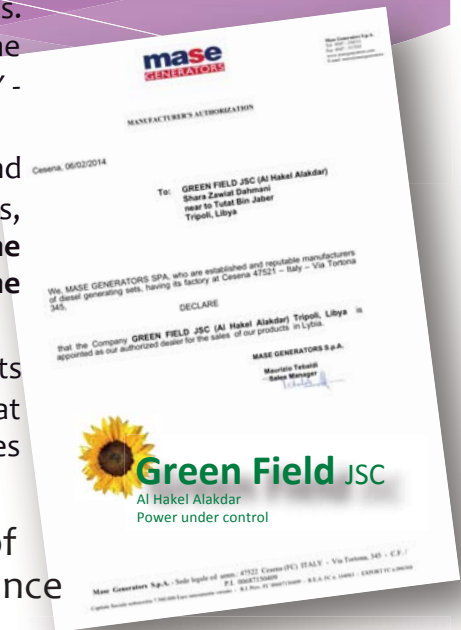

Generator sets Special



Gen set in container
super silent

Military
applications



Welding
machines



Voyager

Gen set for
telecommunications



Tower light



Green Field JSC

Al Hakel Alakdar
Power under control

SUSTAINABLE DEVELOPMENT

- * **Green Field** JSC promotes a sustainable construction industry even in the developing countries.

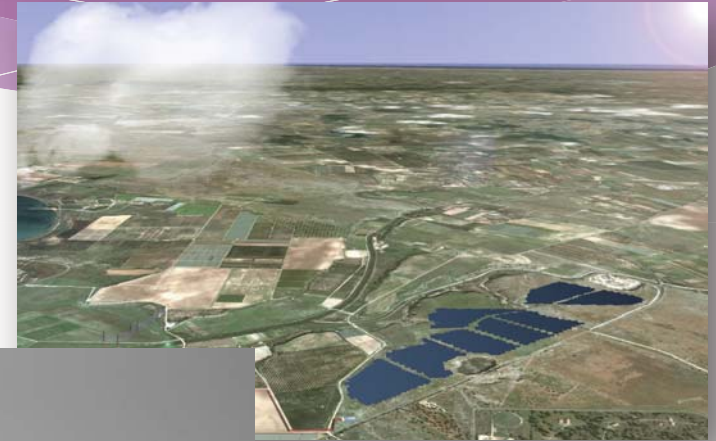
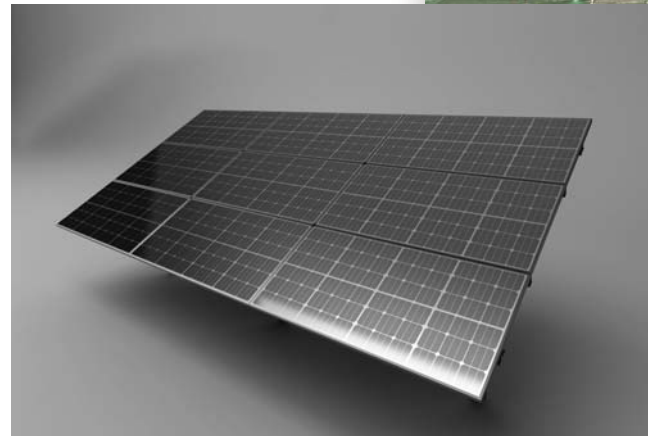

everywhere

- * So we can make an energy system, high-performance enterprise wherever the need requires it, even in the middle of the Sahara.

Libyan Sahara 350 km southwest of the coast



Green Field JSC

Al Hakel Alakdar
Power under control

Integrated production systems

In the following pages we illustrate several examples that demonstrate the usefulness of integration between the different system of energy production than can be monitored remotely by efficient control rooms.



Power energy equipment

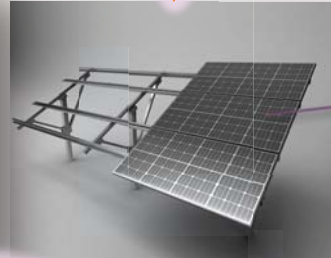

small household systems from 5/30 kw

A



medium plants from 30 to 500 kw

B

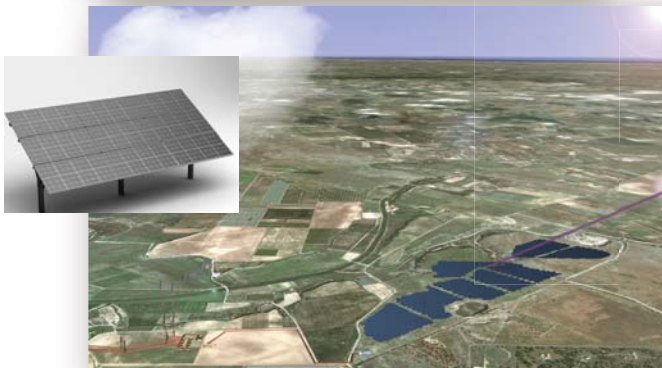

Large-scale power plants of 500 kW at 1,000, 10,000, 100,000 kW, which can give energy to a city

C



Green Field JSC

Al Hakel Alakdar
Power under control

small unit, example
from 5 to 30 KW

A



Daytime

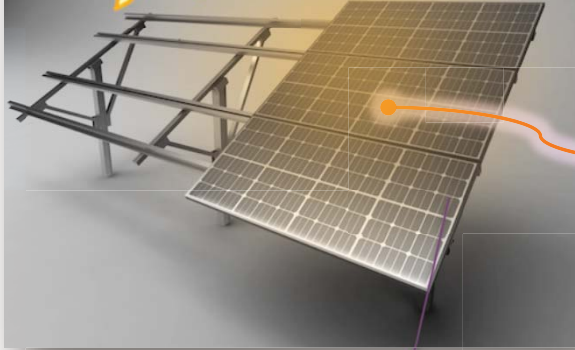

working at night
if there is no power
or anywhere in Libya
even where there is no
power line

PV panels during the
hours of light, the
energy requirements
at **very low costs**

Power needs of the
house



Night

medium unit, example
from 30 to 500 KW

B



Daytime

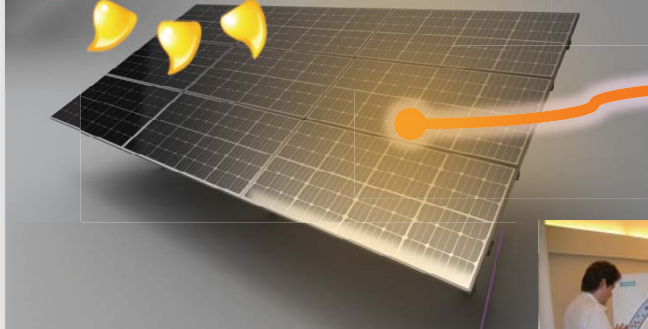

working at night
if there is no power
or anywhere in Libya
even where there is no
power line



PV panels during the
hours of light, the
energy requirements
at **very low costs**

Power needs of the
HOSPITAL



Green Field JSC

Al Hakel Alakdar
Power under control

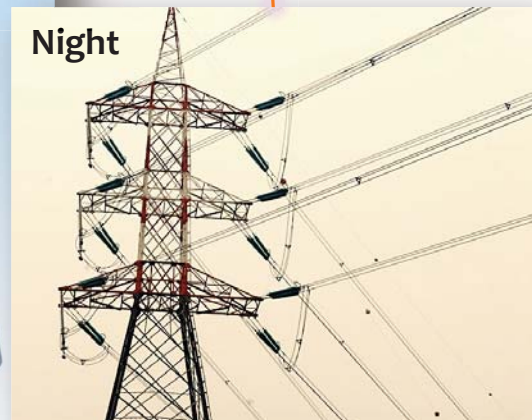



Green Field JSC

Al Hakel Alakdar
Power under control

high power with more than 500 kw

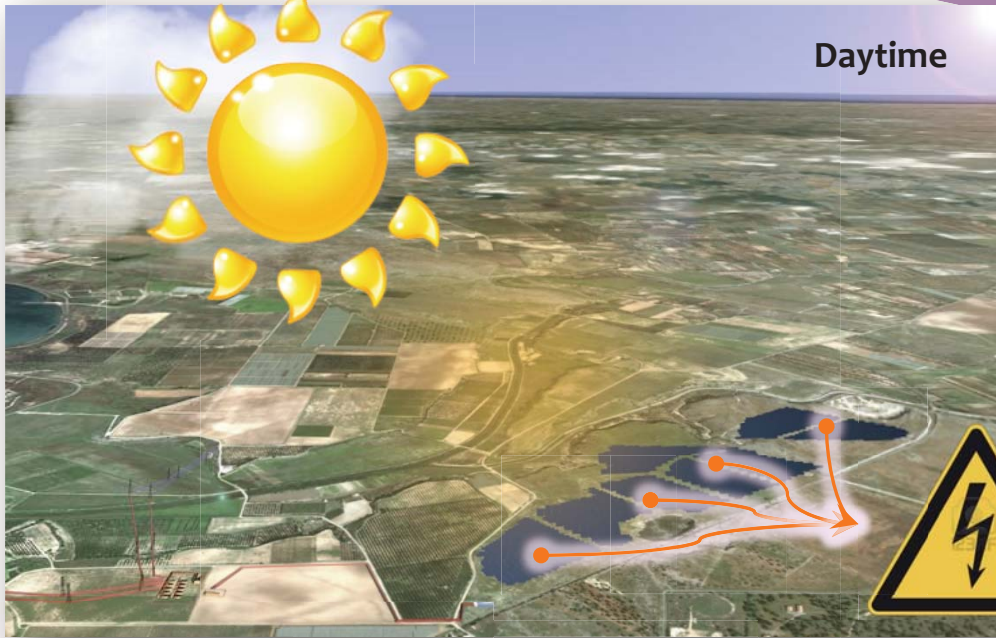

Daytime



working at night
if there is no power
or anywhere in Libya
even where there is no
power line



Night



All power under control

Control room



Main lines

Transformers

Substations

Photovoltaic power plants

Counters under control

Power generators

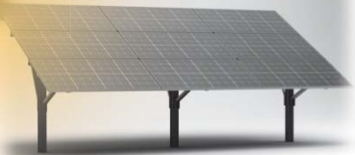
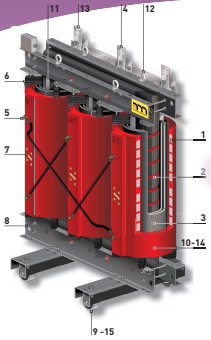

Green Field JSC

Al Hake Alakdar
Power under control

mase
GENERATORS



Green Field Jsc in numbers

Al Hakel Alakdar
Power under control

Green Field Jsc was established in 2009.

Green Field Jsc leads the team of twelve Italian companies specialized in industrial sectors, they have a total turnover of 2012 about 200 million euros with a workforce of 400 people working. The Mission of **Green Field Jsc** is to develop business activities of companies, directly in the destination markets, so as to reduce costs to the end customer.

The main market for **Green Field Jsc** is Libya where it has stable staff and has a base of operations.

Some works



Green Field JSC

Al Hakel Alakdar
Power under control



Some works



Green Field JSC

Al Hakel Alakdar
Power under control





Dr. Salah Zarug

Chairman

Mob. (+218) 091 322 61 90

companygreenfield@yahoo.com

I speak



Eng. Paolo Rattà

Commercial and technical department

Mob. (+218) 091 484 90 35

(+39) 346 027 70 16 (Italia)

companygreenfield@yahoo.com

I speak



Green Field JSC

Al Hakef Alakdar

Power under control

Zawiat Dahmani

near to Tutat Bin Jaber

Tripoli, Libya

tel + fax +218213407152

Registration Chamber of Commerce no. 4966 - Company Register no. 15726